

POWERSTAR Sewage Truck

User's Manual



POWERSTAR TRUCKS INDUSTRY CO., LIMITED

<http://www.isuzutruckscn.com/>



Sewage Truck

POWERSTAR

OWNER'S MANUAL

POWERSTAR

Preface

Thank you for purchasing POWERSTAR TRUCKS products. For better using your ISUZU Cesspool Tanker Truck, get the best operating performance, we strongly suggest that before the operation process you should read this manual instructions carefully, and to manipulate the program handily.

The manual detailed describes the performance of vacuum sewage truck, structure, usage, precautions and maintenance of such knowledge. While showing details of the truck, both pictures and description will together help you get better understanding of how to use truck. Before the operation, the skilled operator should carefully read the contents of the manual.

After master the truck performance characteristics, methods of operation and precautions, then could start to operate this sewage suction truck. In order to ensure the staff turnover after the operation, and properly use of the truck. This manual book must be properly kept, shall not be lost and damage.

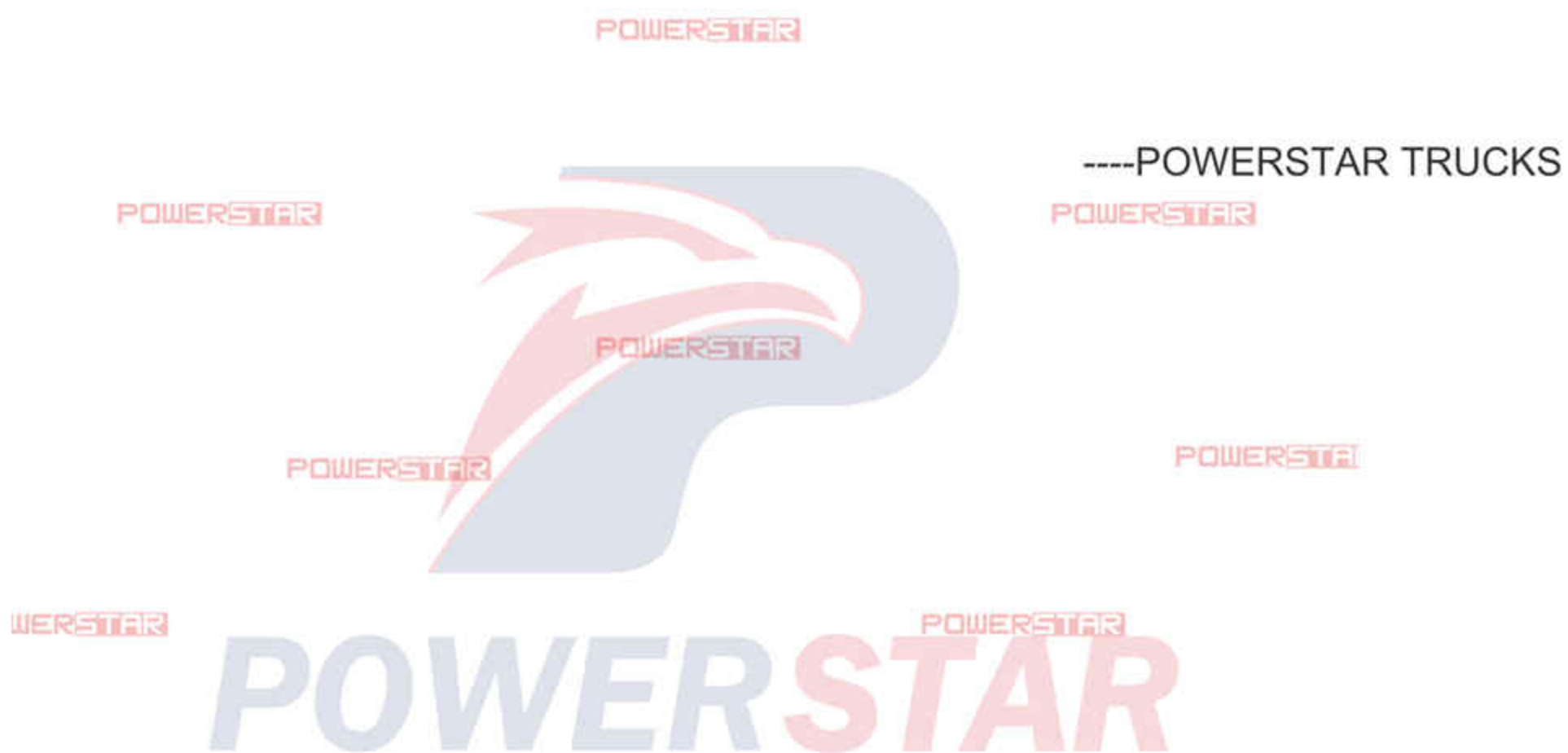

Contents

Chapter 1. General Description.....	5
Chapter 2, Main Technical Data.....	6
i ,Vacuum Tanker Truck technical parameter.....	6
ii ,Vacuum tanker trucks application notice.....	7
Chapter 3, Vacuum Tanker Truck Structure Components.....	8
Chapter 4, Vacuum Tanker Truck Working Principles.....	13
i ,How are the vacuum tanker trucks working?.....	13
ii ,What is the main component for truck?.....	13
iii, How to operate vacuum tanker trucks?.....	13
iv, How to inspection and shipping vacuum tanker trucks?.....	19
Chapter 5, Troubleshooting.....	20

Chapter 1. General Description

POWERSTAR TRUCKS Sewage Suction Truck based on type II ISUZU 4*2 Left Hand Drive chassis, capacity for vacuum tank can be up to 8,000Liters, which also installed with best performed Chinese Top brand WEILONG 68/7000 model vacuum pump. The truck main consists of below system: PTO, Driving system, vacuum pump system, Durable vacuum tank system, Pipeline system, Pipeline storage box, Vacuum gauge, View window, side fence system, etc.

The vehicle designed to fully rely on the advantages of the original of ISUZU brand chassis, fully consider the product's convenience and reliability, also the chassis ISUZU technology features. The vacuum tanker truck has advantage of big capacity and suction efficiently, and maintenance for whole truck can be easily. The tank material is international standard strength carbon steel, which treated with antirust painting both inside and outside.

The ISUZU 4x2 Sewage Suction Truck is ideal and special-purpose machinery used for dredging city sewer, specially applied to pumping, cleaning and transporting the sewage sludge, also can be used for suction droppings and some other works. The truck is widely used for all kinds of suction work in city, high-way service station, airport, community, factory, etc. Therefore, the vehicle is an ideal Vacuum Truck mainly for liquid sewage suction.



(Preview for your ISUZU NPR 8,000Liters Sewage Truck)

Chapter 2, Main Technical Data

i ,Vacuum Tanker Truck technical parameter

Items		ISUZU NPR 8,000 Liters Sewage Truck
S I Z E	Outer Dimension (L×W×H) (mm)	6700x2200x2700
	Wheelbase (mm)	4175
Kerb Weight (kg)		4500
G E A R	Gearbox brand	ISUZU MLD
	Model	6-shift gearbox
	Type	Manual
Cab capacity (includes driver)		2+1
E N G I N	Brand	ISUZU
	Model	4HK1-TC51
	Type	Four cylinder inline, four stroke, water-cool, turbocharged Inter-cooling, diesel
	Rating Power (kW/HP)	141 / 190

Note: 1. The vehicle height includes top filter and overflow alarm.

2. We keep the right to revise the parameters on the list above.

Sewage Suction System basic parameter list

Items		Parameter
Superstructure	Dirty water tank	8,000 liters
	Material	Carbon steel, 6mm thick
	Design pressure	Full Vacuum – 0.9bar
	Vacuum pump	WEILONG 68/7000
	Water jetting system	China famous
	Water tank capacity	20 litres
	Suction Pipeline	PVC hose with 4" diameter, 7m long
	Full-suction time	≤5min
	Discharge valve	6" discharge valves
	Rear cover	Hydraulic open and Manual locking

ii ,Vacuum tanker trucks application notice

(1) Keep the vacuum pump at suitable revolution speed:

If the pump too speedy, the rotor's temperature will be very high; on the contrary, the pump too slowly, engine knock will happen, which will impact the parts and affect the service life. In one word, the proper revolution speed is necessary, and should have the HAND THROTTLE to the largest adjustment position in advance.

(2) Rollover the tanker on flat road

Rollover the tanker on the tilt road will not only make parts distortion and lead to malfunction, but also an accident.

(3) Open rear door before rollover the tanker

Open rear door before rollover the tanker is very important, or there may be an accident.

(4) When clutch pump and vacuum pump take power form PTO, have the engine idling, and completely press the clutch pedal, then slowly lift the clutch pedal.

(5) NOTES: Keep the PTO box's joysticks in middle position while driving.

(6) Waste oil and other danger things are not allowed to be carried by this vehicle.

(7) The supporting rods and safety stop must be used while tanker is raising position before entering the base or repairing the tanker.

(8) When transporting sewage, the manual rear door clamping device must be used to keep safety. For there are no water cutter and the high barycenter, the vehicle also must drive at middle or low speed, and must not turning and braking suddenly.

Chapter 3, Vacuum Tanker Truck Structure Components

Overview for ISUZU Vacuum tanker truck technical drawing:

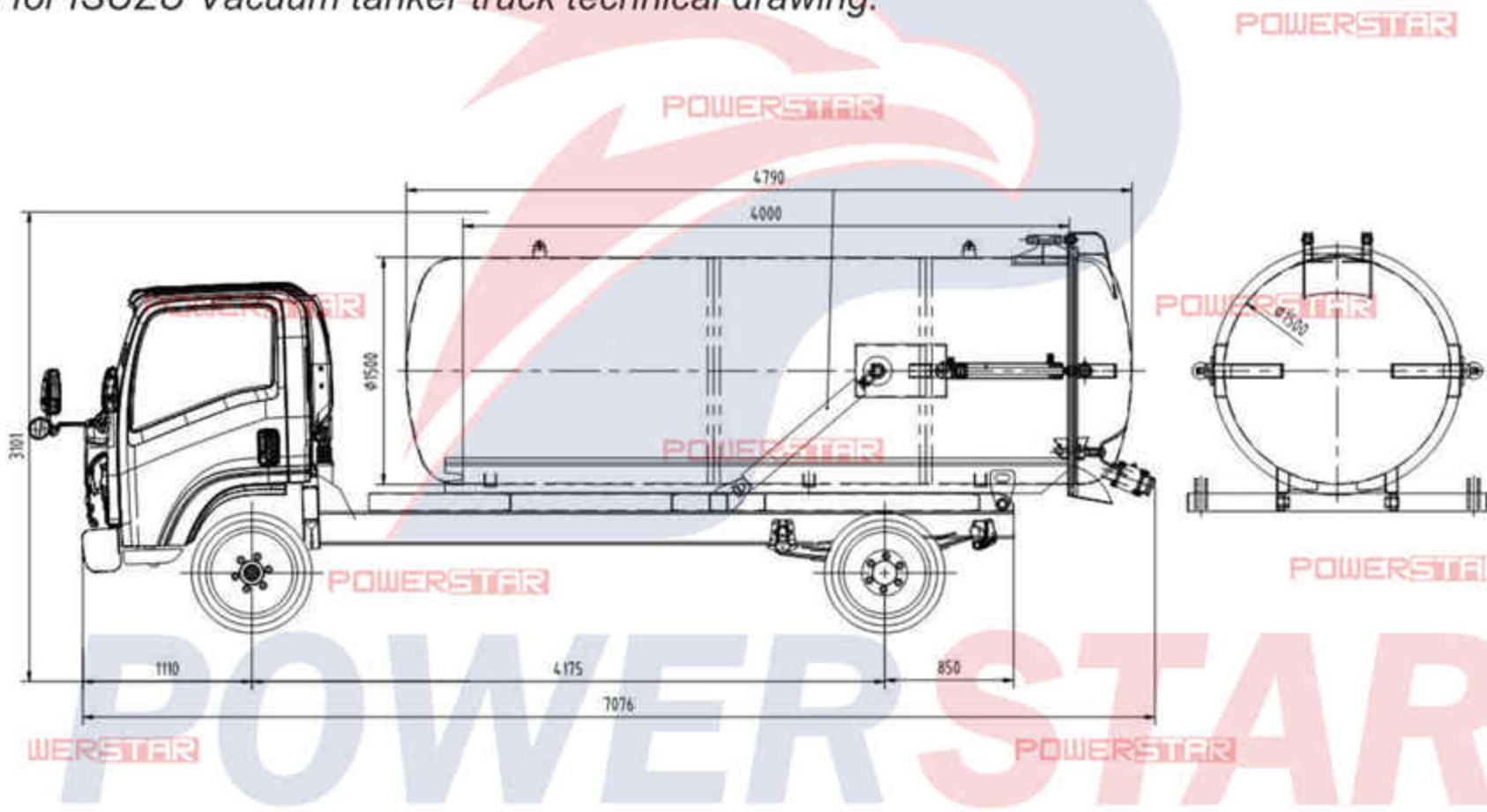

- MAIN PARTS:
- 1, air operated valve
 - 2, PTO box joysticks
 - 3, vacuum pump
 - 4, manual operated valve
 - 5, four-way valve
 - 6, oil-gas separator
 - 7, rollover oil tanker
 - 8, suction valve
 - 9, open-door cylinder
 - 10, discharge valve
 - 11, rear door clamping device
 - 12, scupper valve
 - 13, suction soft pipe
 - 14, safety alarm

Above drawing show detailed parts for this ISUZU ELF vacuum tanker truck, which use original ISUZU type 2 chassis, with white color single row cabin, wheelbase 4175mm, 4HK1-TC61 engine with 190PS, manual MLD 6-shift gearbox, 235/75R17.5 tires with 6+1 units, detailed picture for chassis as below:



Pictures show customer required chassis for record

Vacuum Pump: famous Chinese brand WEILONG 68/7000 vacuum pump, which installed below of the tanker system

Vacuum pump system, below of tanker, Driver side



Manual Operated Valve: equipped at side of the platform, which control the vacuum tank rise / fall, and rear door open / close.



Vacuum System: equipped with Four-Way Valve, Second Level Oil-Gas Separator, water-Gas Separator.



Pump-In Working



Nonworking



Pump-Out Working

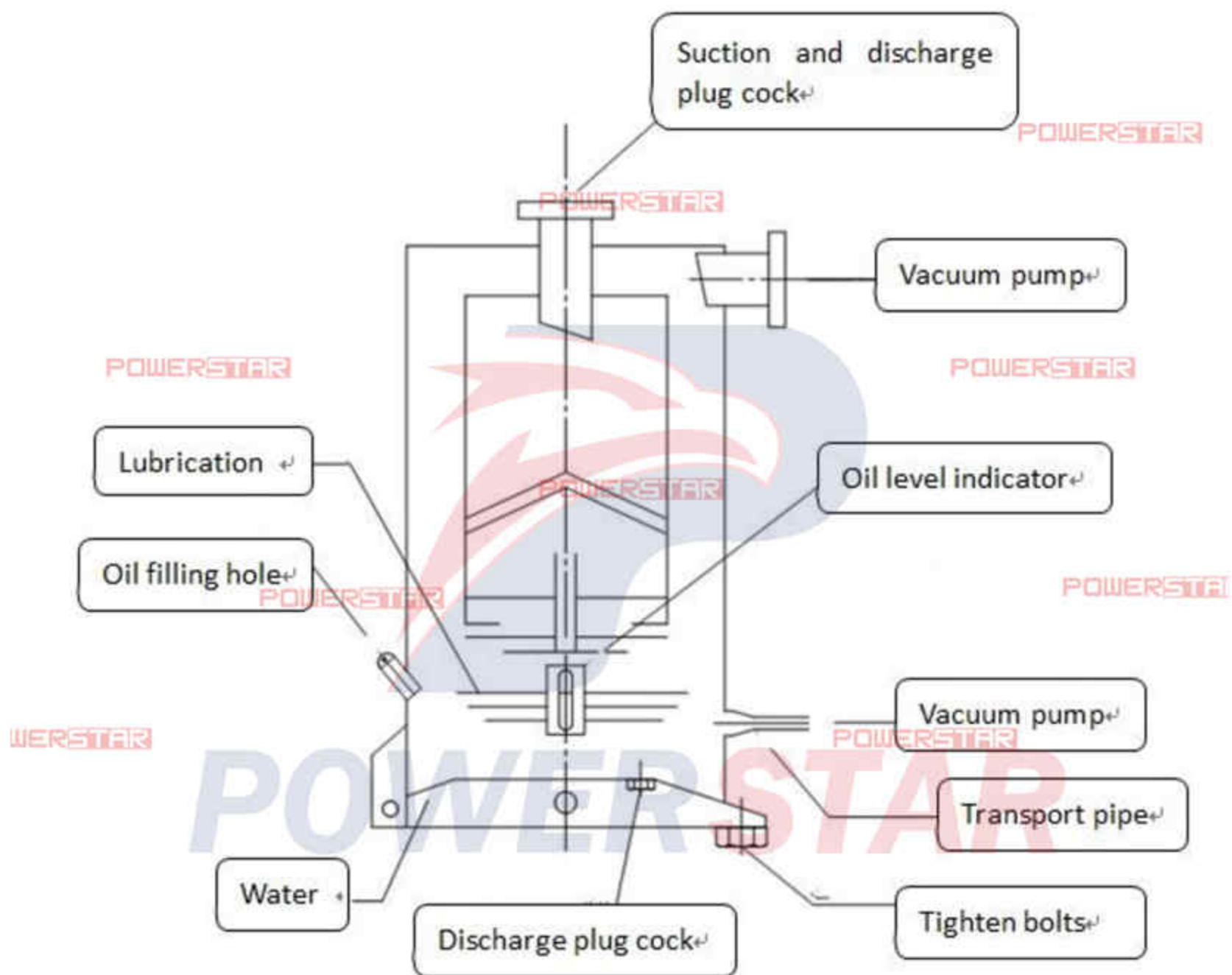
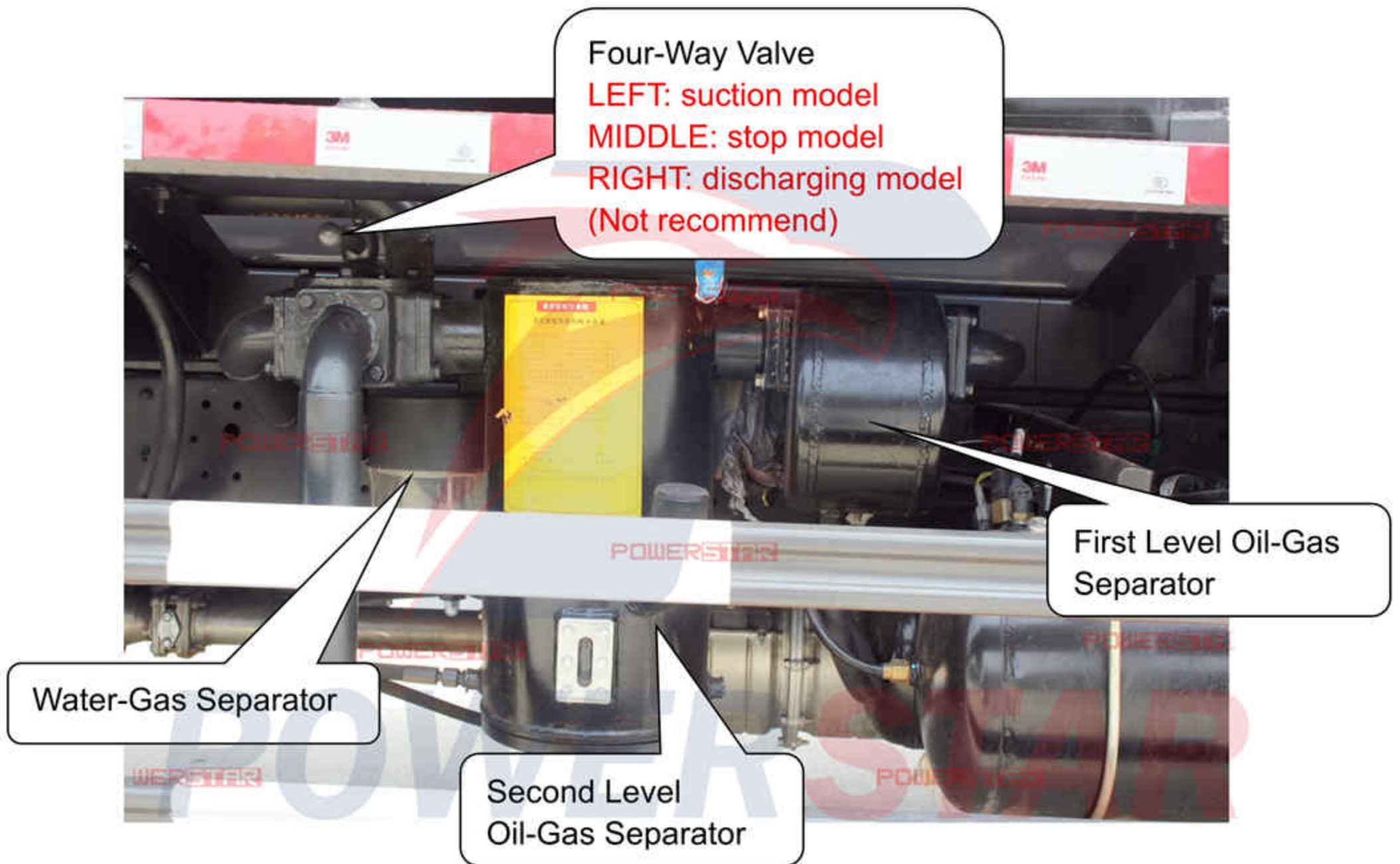

(Second Level Oil-Gas Separator)

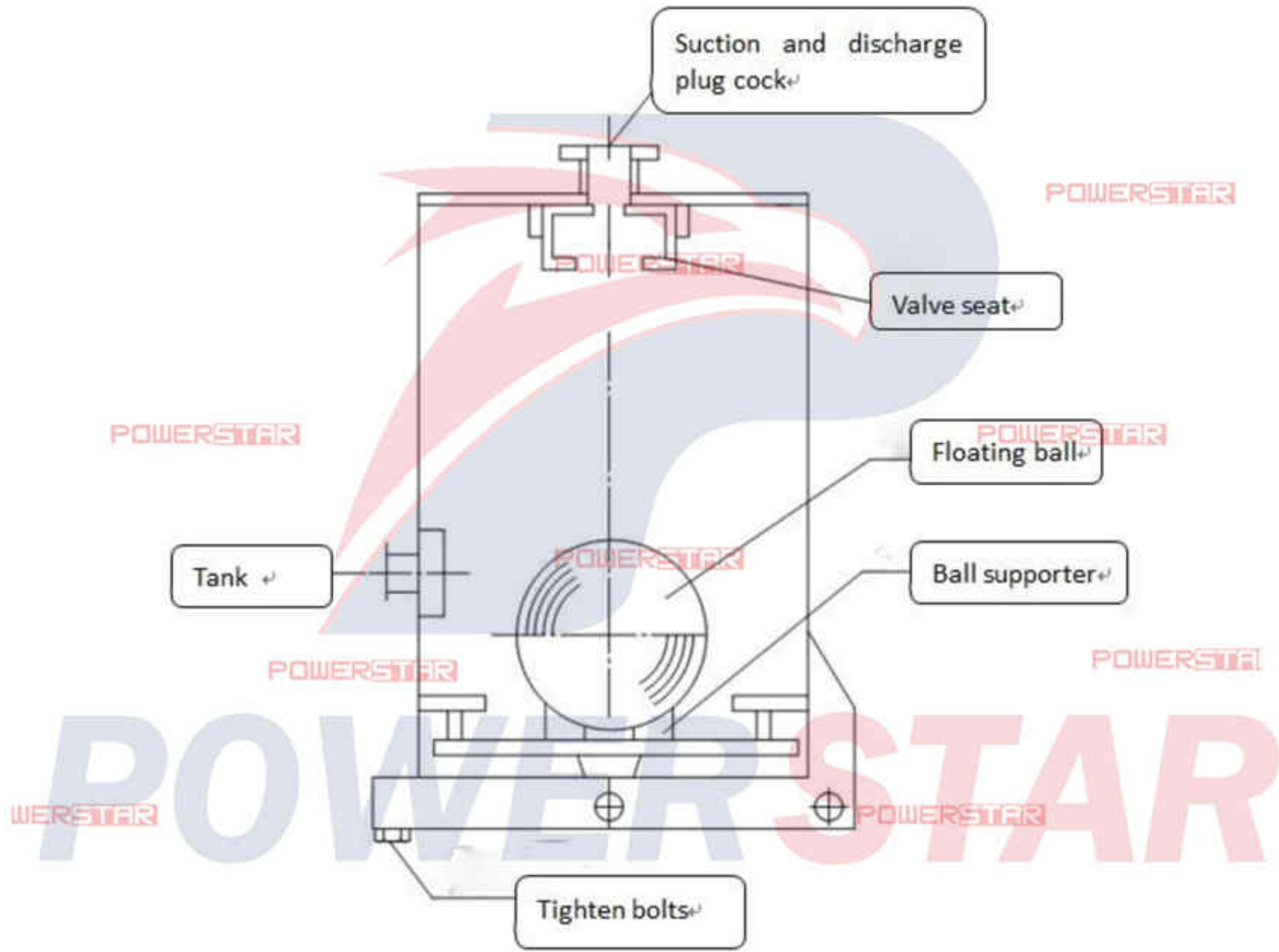

(Water-Gas Separator)

Whole view of the Truck Tanker:

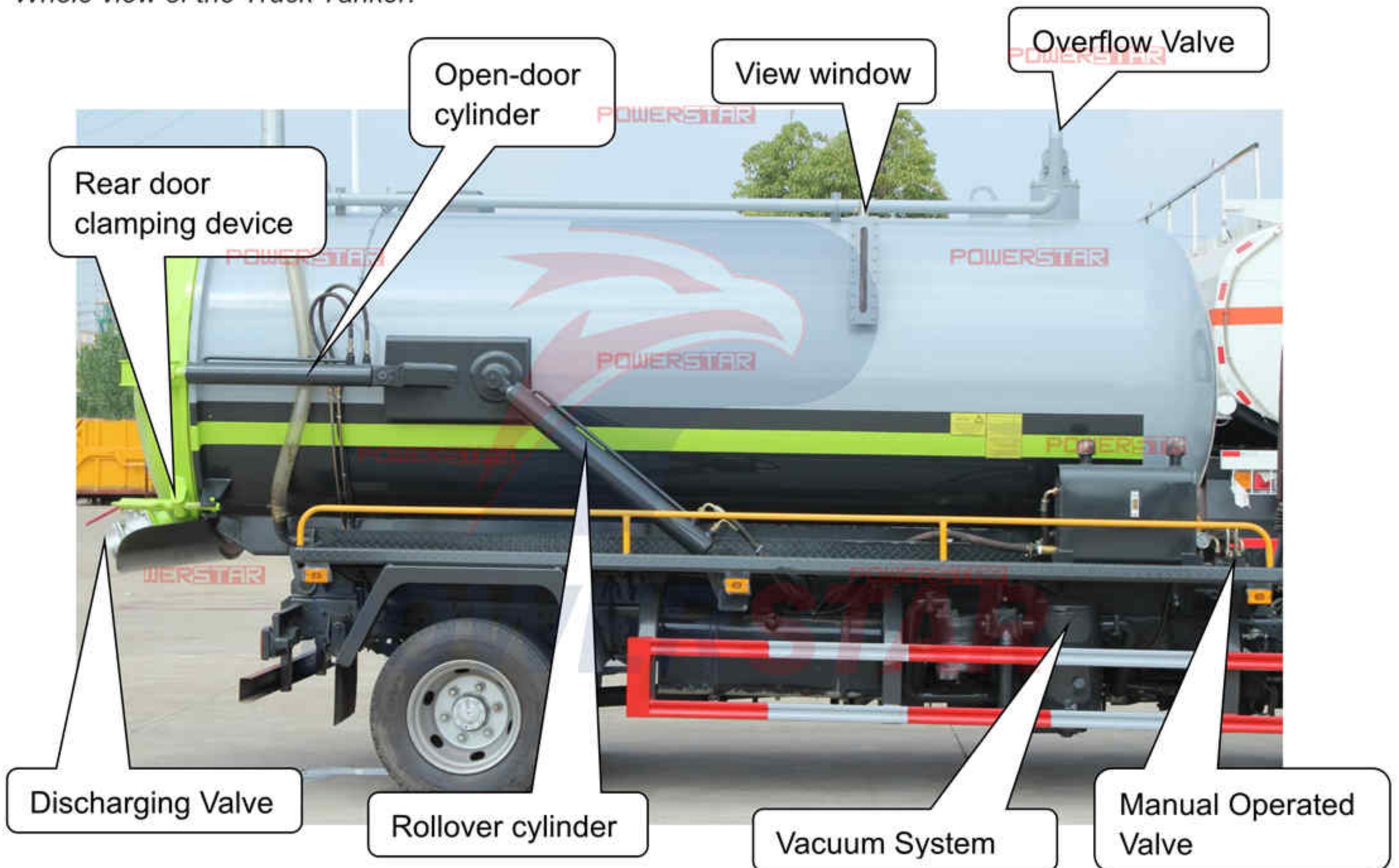

PTO of the vacuum truck, press the Clutch then can operate the PTO:



PTO:
Pull Out-----PTO is ON for working
Push In-----PTO is OFF not working

Level Alarm Button:
Pull Out-----Button is ON for working
Push In-----Button is OFF not working

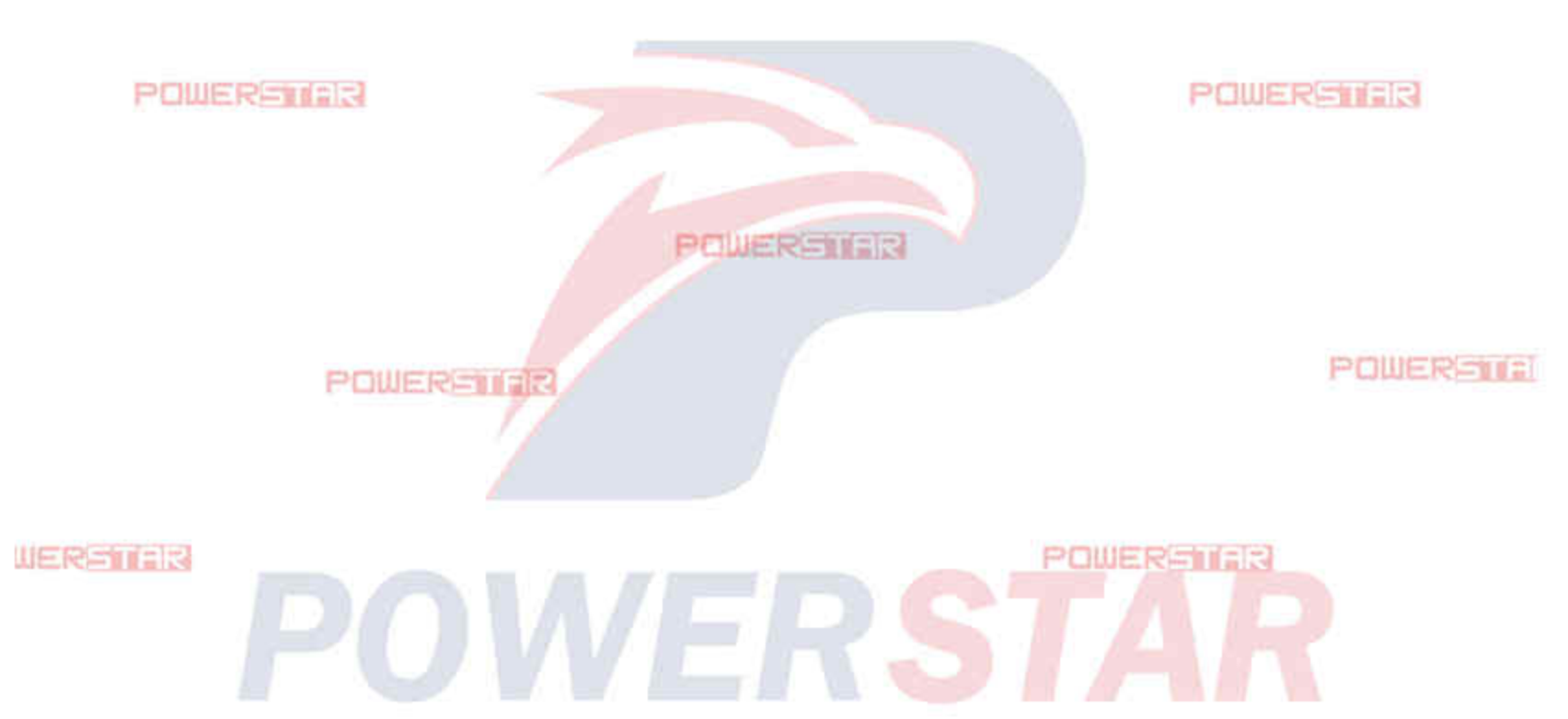

Chapter 4, Vacuum Tanker Truck Working Principles

The operator should fully understand Whole Structure and Working Principle for ISUZU ELF Vacuum Tanker Truck before any operation. Only trained person can operate this vehicle properly and to prevent unnecessary accidents and equipment damage.

i ,How are the vacuum tanker trucks working?

The ISUZU Vacuum Tanker Truck makes use of the PTO to get the power from truck engine, and the power drive the vacuum system working. Operation the valves to control the truck suction liquid sewage, adjust the throttle knob to make suction speed faster and slowly. After suction working, using Manual Operated Valves to control rear door Open/Close, and sewage tanker Rise/Fall. After working, cleaning the sewage tank, and ready for next time operation.

ii ,What is the main component for truck?

The vacuum tanker truck is refitted based on the ISUZU ELF 4x2 LHD chassis. The refit part includes Vacuum suction assembly, actuator device and operation system.

- Vacuum suction assembly: One round shape vacuum sewage tank. 1 unit suction pipeline, whole suction system, including vacuum pump and system.
- Actuator device: includes PTO, drive line, etc., which can pass the power to the pump.
- Operation system: helps come to all special functions' convert.

iii, How to operate vacuum tanker trucks?

(1) Suction operation preparation

- A, Keep the sewage tank rear door closed
- B, Carefully check whether the lubrication of vacuum pump gas-oil separator working normally.
- C, Press the clutch pedal and pull out PTO button to make PTO, Vacuum Pump and Gear Pump Working.



(2) Operations sequence (Detail figure)

A, Press the clutch pedal, adjust the PTO button, to get power from the truck engine and start the vacuum pump, then slowly release the pedal.

B, Start the safety alarm (in the cab)



C, Adjust the hand throttle joystick to largest position, and keep the revolution meter point to 500-600r/min (already has been set before out the factory)

D, Adjust the four-way valve to suction position (Front to **LEFT POSITION** and Rear to **RIGHT POSITION**), carefully check the released air, the vacuum pump sound, the vacuum meter.



Pump-In Working



Nonworking



Pump-Out Working

Please Note: Only suggest use vacuum pump for Pump-In working, strictly forbidden for Pump-Out working

E, Put the suction pipe into the sewage. Park the vehicle in right place before suction working, which can keep the pipe straight or free bending state, and guarantee vehicle work normally.

Each truck equipped with 1 unit 7m pipeline DN100, and 10 units 20m pipeline DN76

Firstly connect 7m pipeline with valve, and then connect 20m pipelines if need.

Suction Pipe:
One head connect with this valve
One head into the sewage pool



(3) Attention while working

A, Things like over 50mm stone, cotton yarn, leaves etc. will block the suction pipe, and should not be

suction, also should keep the pipe clean and unblocked.

B, Keep the suction valve full open while vacuum meter point to 65-80kpa, because half-open may damage the valve.

C, The suction pipe should be moved frequently while suction. Because suction some air and water will increase efficiency when the sewage is too viscosity.

3, Waste water discharge operating instruction.

After sludge and waste water separate, open scupper valve to discharge all the waste water and be ready for next suction. Pressure can bigger while discharging water. Operation approach as follows:

A, Adjust four-way valve joystick to nonworking position, then open the discharging valve to open position, and discharge all the waste water by gravity. (**Recommend**)



Nonworking Position



Open Rear Discharging Valve

B, Adjust four-way valve joystick to discharge position, then the vacuum pump keep working, and the pressed air goes into tanker to put waste water quickly out of the tanker. (**Not Recommend**)



Pump-Out Working

C, When discharge by pressure, firstly, open the discharge valve, then adjust discharge valve joystick to discharge position, in case of tanker pressure become too high, some accident and bad influence on rear door sealing.

4, Muddy discharge operating instruction

(1) Press the clutch; turn on the air operated valve or adjust PTO box joystick to make oil pump running.

(2) Rear door clamping device valve to discharge some waste water, and adjust the inside tank pressure to be equal to the outside pressure.



(3) Open the rear door clamping device, loosen the handgrip and completely take off screw.

(4) Adjust the rear door manual operated valve to open rear door, please be sure the inside and outside air pressure is equal before open the door. If the pressure is not equal, the door seal and oil cylinder may be damaged.

(5) Recovery operation after discharge the sludge: adjust manual operated valve joystick to DECLINE position, and carefully exam the follow things after the tanker reposition.

A, Carefully check the tank door flange and seal ring, and clean it if dirty.

B, Adjust manual operated valve joystick to CLOSE position, closes the rear door.

C, Operating the rear door clamping device until the rear door closed completely.

POWERSTAR

POWERSTAR

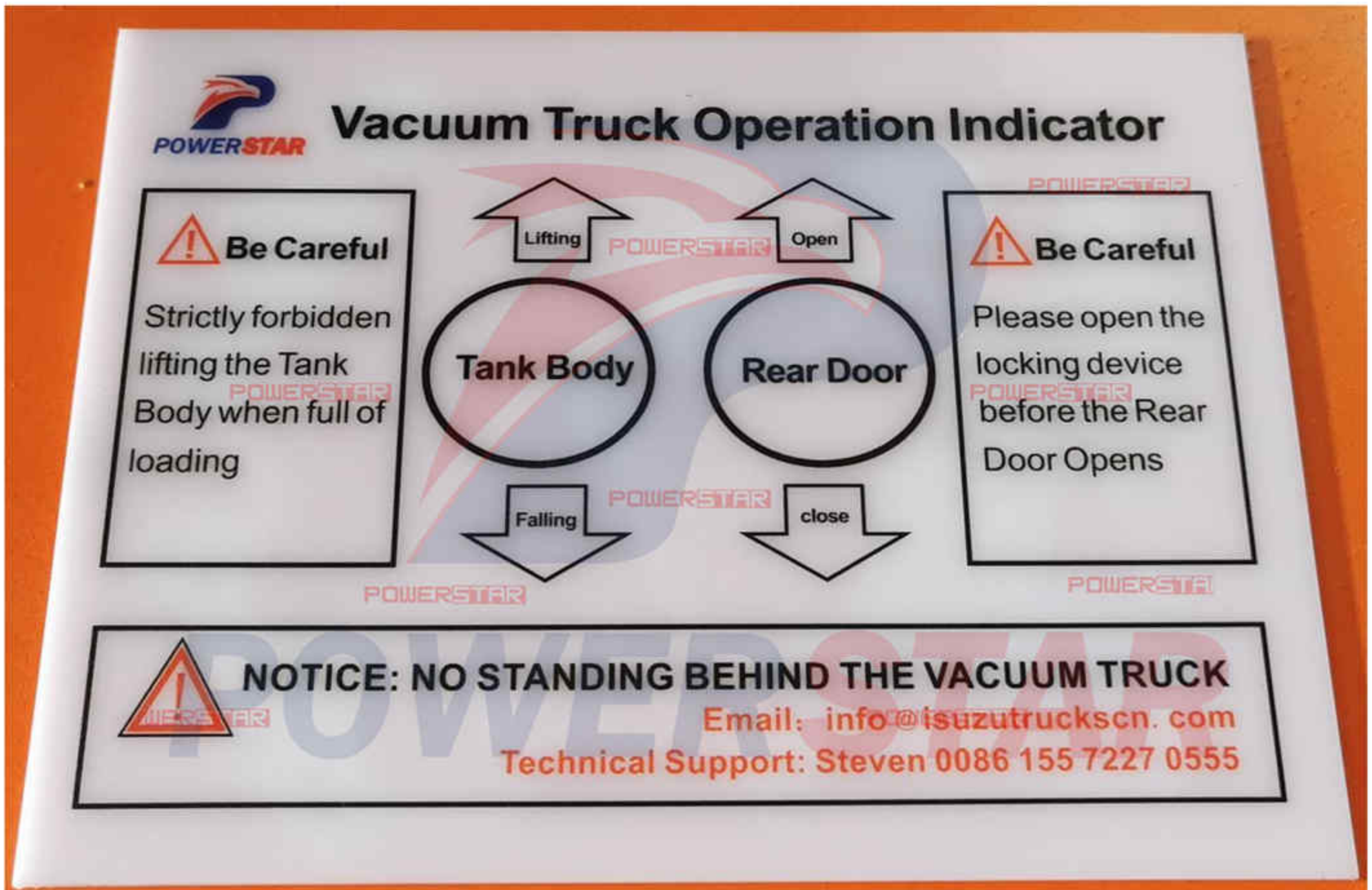

Note: Please open the clamping device first before open the rear door.

Operation Method:

First Manual Joystick **1**: Control the Tank Body Lifting Up / Falling Down
Push In-----Tank Body Lifting Up
Pull Out-----Tank Body Falling Down

Second Manual Joystick **2** Control the Rear Cover Door Open / Close
Push In-----Rear Door Open
Pull Out-----Rear Door Close



iv, How to inspection and shipping vacuum tanker trucks?

Our Engineers can design the vacuum truck dimension, so can make sure it can loading into 20GP, 40GP, 40HQ shipping container, which can save much shipping cost. And customers can come to our factory for visiting and Isuzu trucks inspection before shipment:



Chapter 5, Troubleshooting

After carefully reading the above information, you must be well known how to use the ISUZU Vacuum Tanker Truck; below show some important parts to help solve problems.

